



AXEL CAM 20
CAMERA FOR INTERACTIVE BOARD



AXEL CAM AC20

Cost Effective and Simple Solution for multi party conference

With AXELBOARD H and M2 Series NFC INTERACTIVE BOARD



Ergonomic Design



Easy Installation and Setup with Simple operation



Receive 4k video

2

Product Overview

High Resolution Video Camera with Array Microphone

8MP Camera

Transmit and Receive 1080P Resolution.

Array Microphone with 10m voice pick up



3

Features

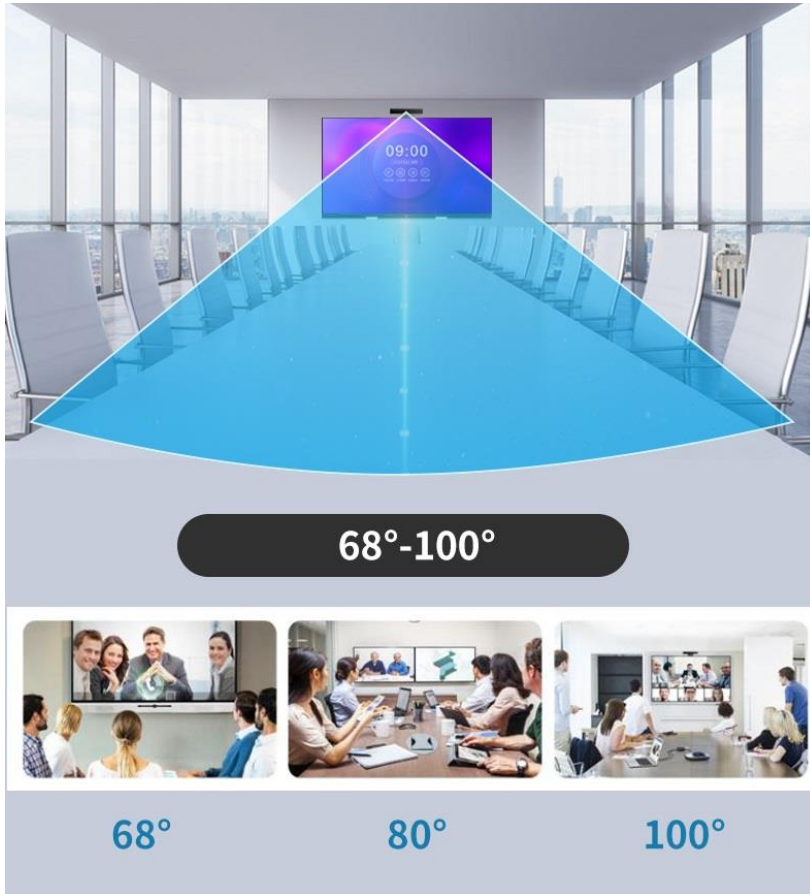

- 100 deg wide angle
- 1/2.5" CCD Camera
- 8MP Camera
- 5x Digital Zoom
- Focus : Autofocus
- Resolution: 1920x1080@30fps, 1280x720@60fps, 1280x720@30fps
- Video Coding : H.265 , H.264 SVC
- Array Microphone: 10m voice pickup



3 Features



- **Windows and Mac ready**



Features



- **5x Zoom**



Features

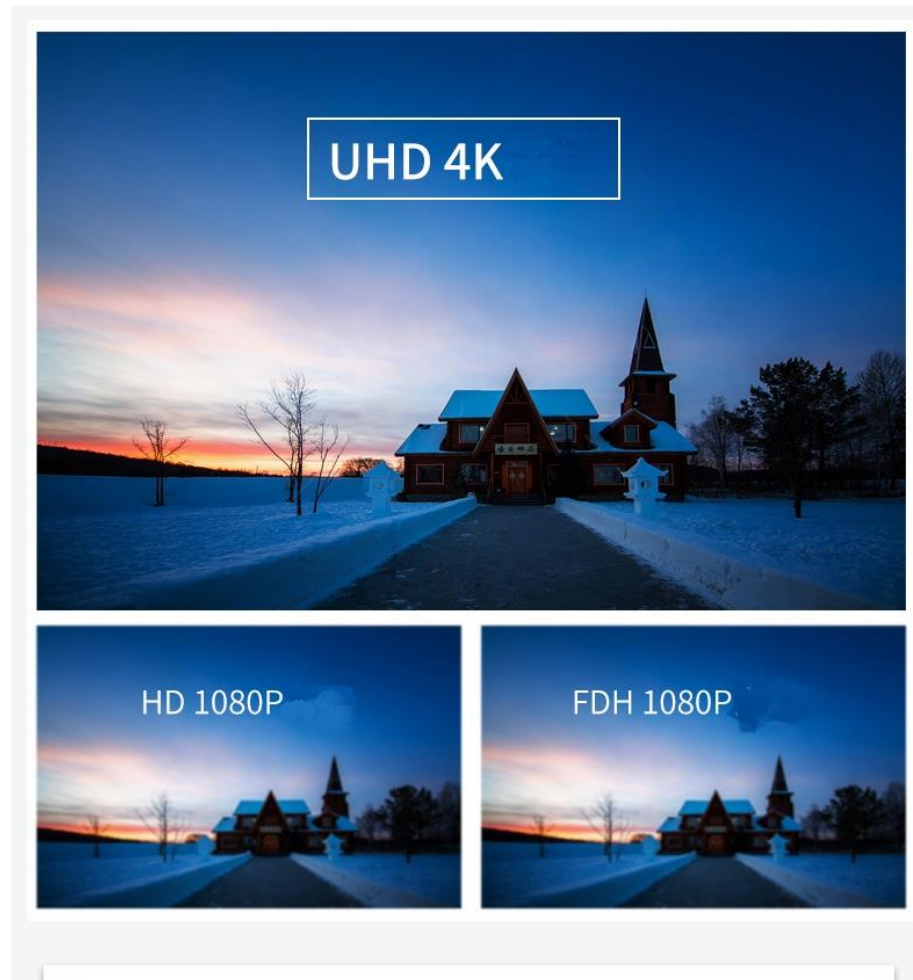

- **UHD 4K**

3

Features

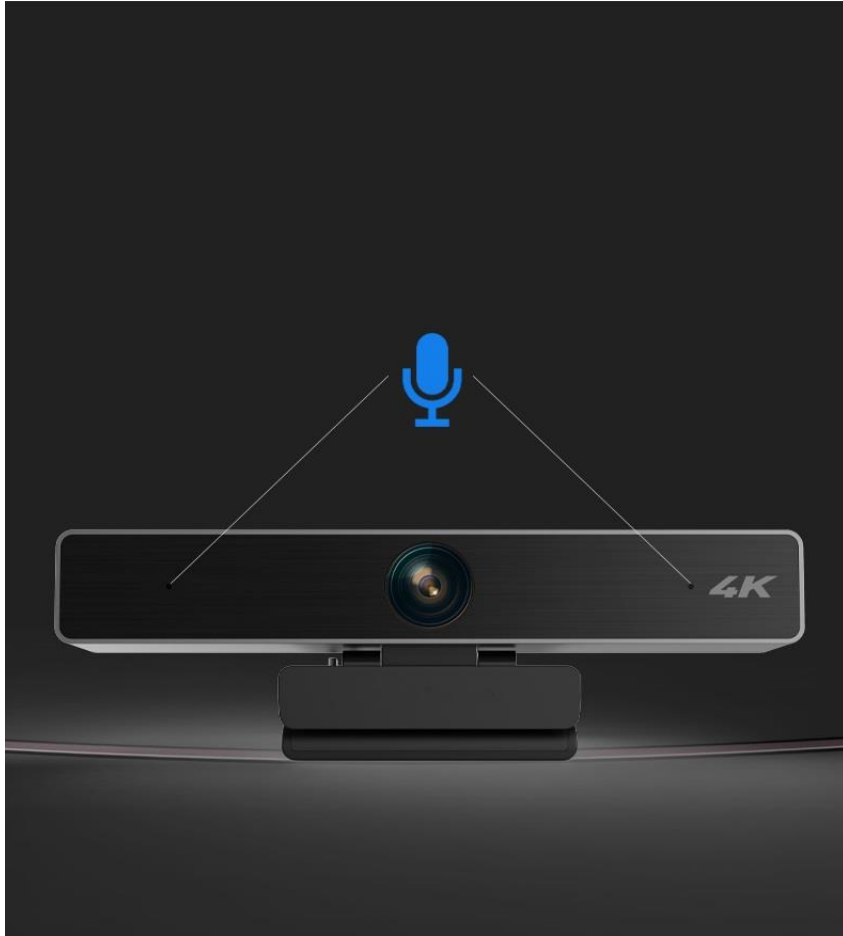

- 8 microphone array
- Support infrared receiving
- USB 2.0
- 10m range



4 Dimension

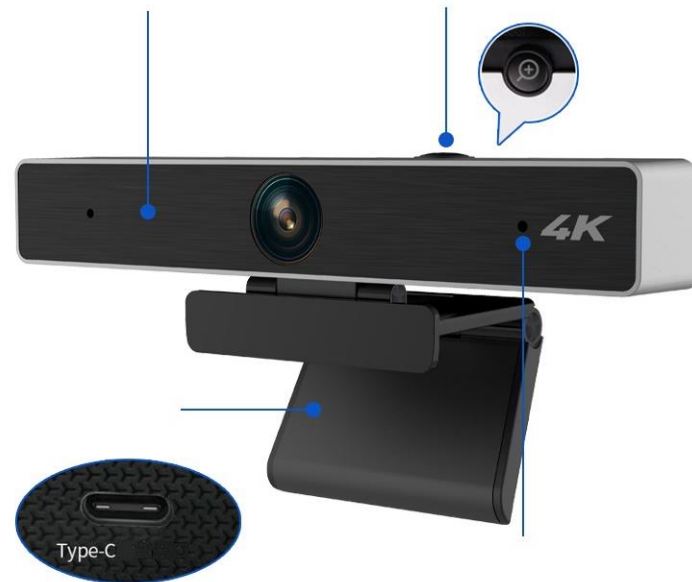
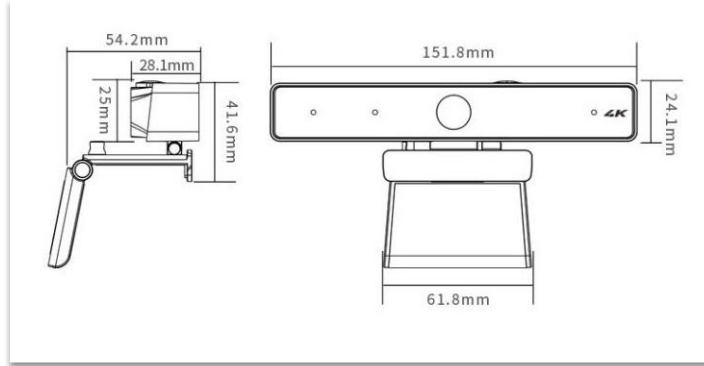



Installation

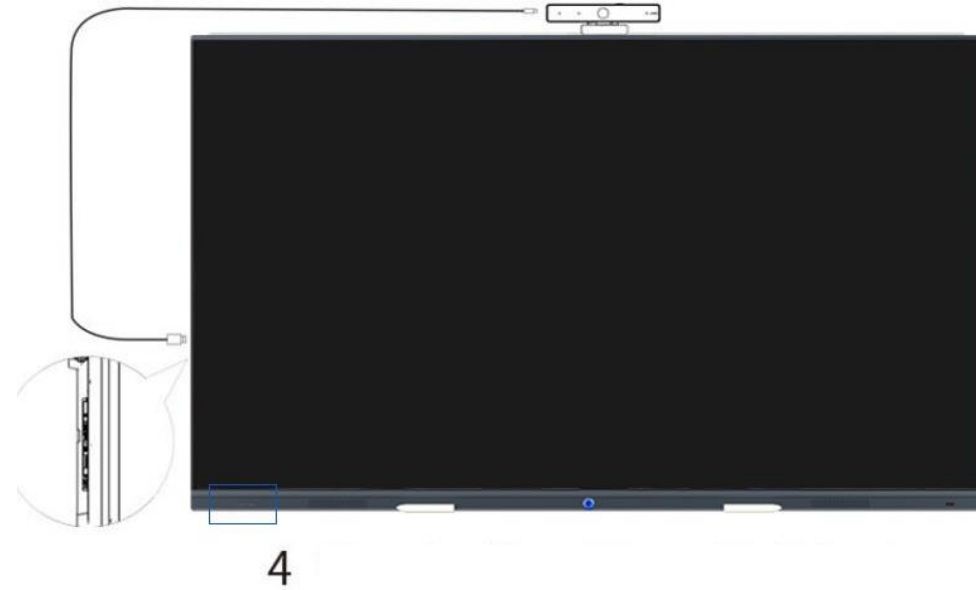
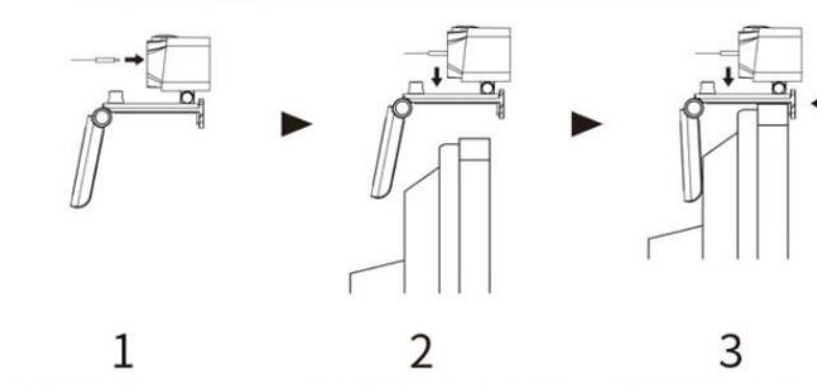

5

Use Case



AC2.0 CAMERA with AXEL BOARD

APPLICATIONS:

1. CONFERENCE CAMERA For corporation, government, education and businesses using Zoom, Skype, Team and Google Meet.
2. RECOGNITION CAMERA For Attendance, Behaviour Analysis, Welcoming Guests
3. SURVEILLANCE CAMERA For Security and Monitoring.

THANK YOU